

SR 680

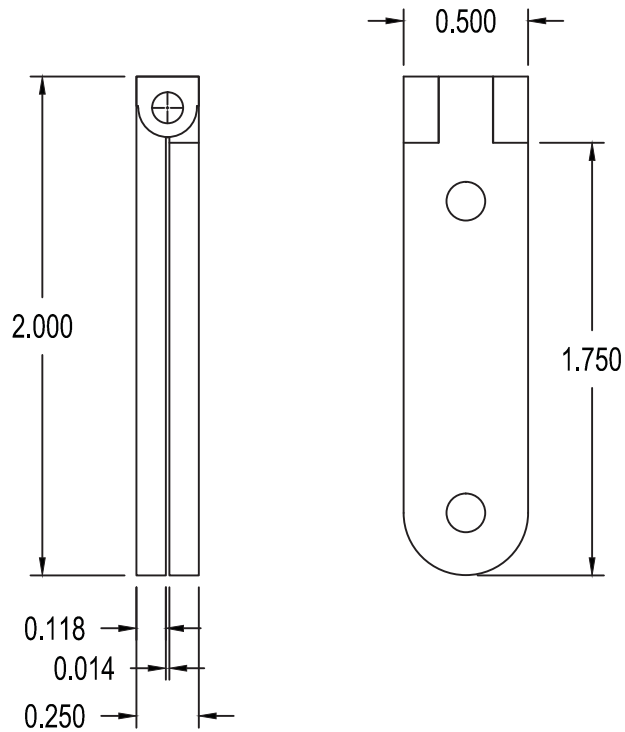
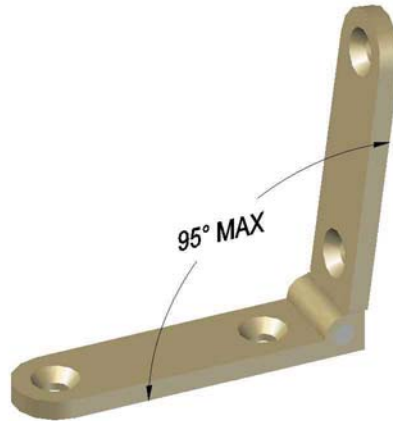

Questions- Call before mortising 212-337-8510

BRUSSO [®] <i>American Made</i> PRECISION HARDWARE	© 1983-2012 Brusso Hardware LLC 67-69 Greylock Avenue Belleville, NJ 07109 T 212-337-8510 F 212-337-9840	Product: SR 680 STOP HINGE		Revision: 0
		Component: TEMPLATE	Material: BRASS	File Name: SR 680 STOP HINGE
Tolerances unless otherwise specified: Machined features fraction $\pm 1/64$ Decimal .xxx $\pm .005$, Angular ± 1 Degree, Hole Diameter $+ .003/- .002$		Catalog No: SR 680	Drawn By: KA	Checked By: RB
		Scale: NONE	Date: 5/25/13	Date: 6/1/13
			Sheet: 1 of 4	